



Manufacture & Supply of Neonatal System

Transport Incubator

Model:320



Infant transport Incubator 320

Incubator for warming and intensive care of new born babies during transporting

The transport preterm birth from one hospital to another is the most difficult start into our world and a challenge for the physicians, nursing, staff and parents. Day by day they do their utmost to facilitate the baby's ongoing health.

The transport incubator 320 helps to achieve this aim. It combines the climate stability of a closed environment with increased access and contact possibilities offered by open care systems.

In the majority of cases preterm babies can stay in the transport incubator in the first few months of their while need to transport. Therefore a calm environment is an important factor for their future development. An optimum air flow guide system minimizes the generation of noise in the portable

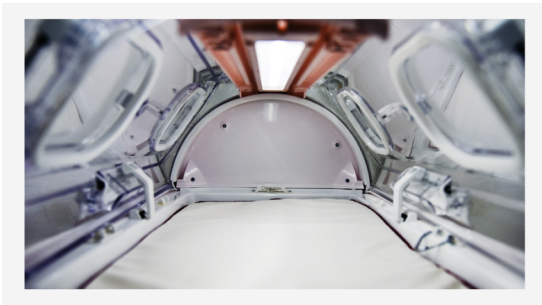

Always the right climate

Air and skin temperature are selected according to the baby's needs and are servo controlled. A brand-new air flow technique warms the patient evenly by minimizing the transepidermal humidity loss.

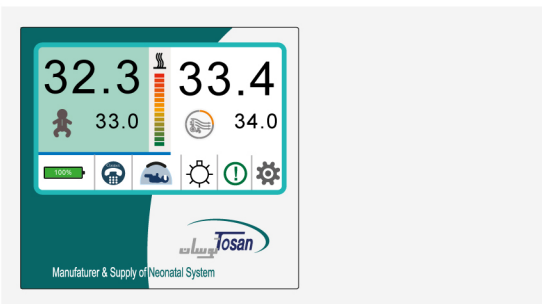

Monitor / operator terminal

Innovative technology controls and monitors the selected values of air and patient temperature oxygen concentration. The selected parameters and measured values are indicated and clearly structured with a graphic display. 4.3 inch graphics display with touchscreen that enables you to display the following parameters:

- Air & Skin Temperature
- Battery life & Charge level
- Alarms
- Cabin lighting
- Phototherapy
- Setting

Temperature Adjustment



20° ~ 37°



20° ~ 37°

Heat control

Using the latest technologies, the time to reach the target temperature has been reduced to less than one minute.

Also, infant chamber temperature fluctuations have been minimized with respect to ambient temperature changes.

Temperature adjustment interval for incubator air & skin temperature is between 20 ~ 37 ° C and incubator temperature display interval is between 15 ~ 40 ° C.

Ergonomic design / Baby Access

The front and rear doors are easily open for easy access to the baby and stabilized in place after V- degrees of rotation also the front and rear doors has four large hand port windows which can be opened quickly and easily by pressing the unlocking mechanism (also with disinfected hands). It is possible to open both hand port windows by one central pressing.



Infant Transport Incubator 320

Convenient, safe, reliable

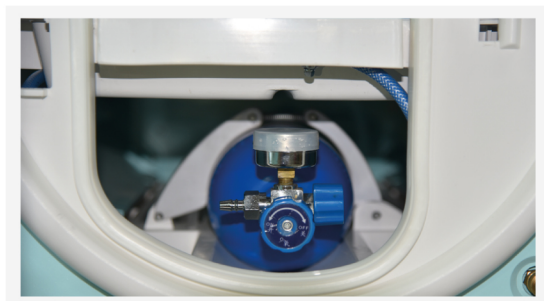
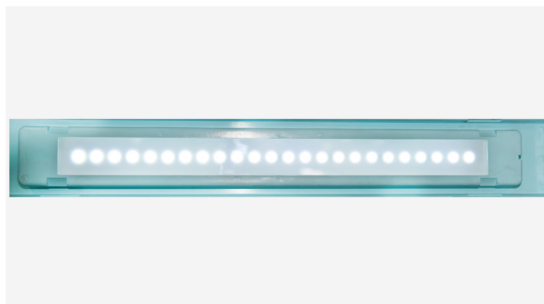
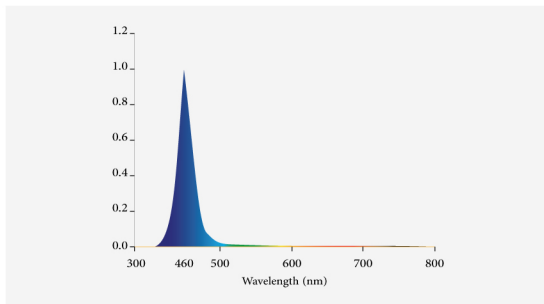
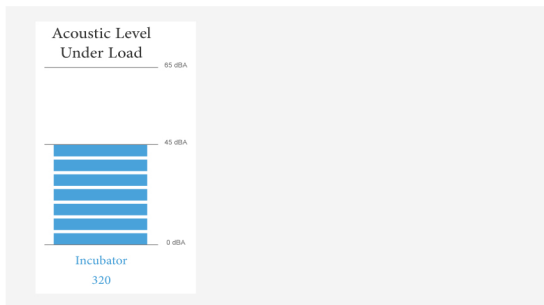

Compartment noise

Ultra low noise level (less than 50 dB) inside the compartment utilizing the latest technology in the world to design air circulation path

Phototherapy

Portable Incubator 320 has a phototherapy system for treating neonatal jaundice under 18 mg in the hospital, during transport, or in an ambulance.

- Wavelength of 450 nm
- Power of 12 watts
- life of 30 thousand hours.

Lighting inside the compartment

The LED light bulb with 3000 kW power of 2 watts is used in portable incubator 320.

These lamps have natural brightness for the treatment of infants, which can also show the true color of the baby's skin in the dark.

oxygen tank

The incubator uses three different types of power supply for different conditions.

- AC power supply
- Built-in battery
- 12V DC External Power Supply.

All 3 power supply models meet EMC standards.

Additional Specification

Dimensions and weight	Weight	41 Kg
	Dimension of patient deck	300 * 500 mm
Alarms	Air sensor error	Audible and visible
	Skin sensor error	Audible and visible
	Air circulation interruption	Audible and visible
	Power supply interruption	Audible and visible
	Temperature deviation	Audible and visible
	Low battery	Audible and visible
Operating parameters	LCD touch screen	3 inch touchscreen graphics display
	Oxygen tank	2 liter
	Intelligence battery	3 hours to fully charge the battery
	Air temperature	28 - 37° c
	Skin temperature	33 - 38.5° c
	Inside noise level	< 40dB
	Cabin light	3000 KW 2W
Phototherapy	450nm 12W	
Electrical parameters	Voltage AC Power & Energy consumption	100-120 VAC 50-60 Hz 177 W
	Voltage AC Power & Energy consumption	200-240 VAC 50-60 Hz 177 W
	Voltage DC(EMS) & Energy consumption	12 VDC 150 W
Classification according to Directive 93/42/EEC		

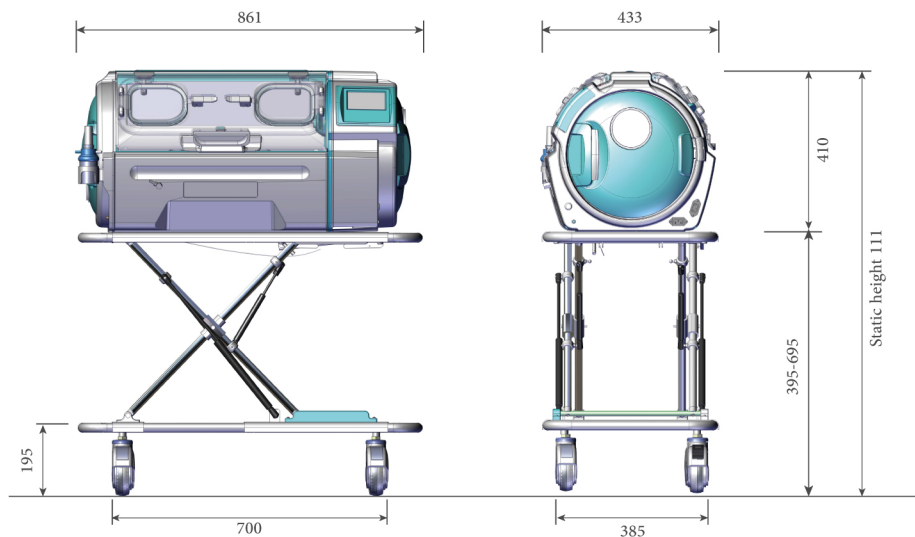

Head Office: First south floor, Chehelsotoon Building, north Allameh, Saadat Abad, Tehran, IRAN

Telephone: (+98-21) 22097416-7

Fax: (+98-21) 22362814

Web: www.tosanco.com
E-mail: info@tosanco.com